

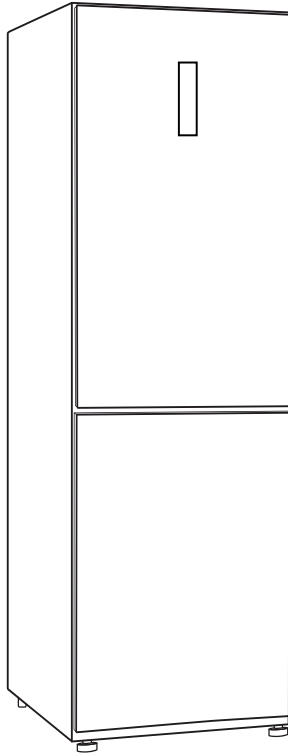

TEKNIX



INSTRUCTION MANUAL

FRIDGE FREEZER

FFH1860X

Contents

Thank you for choosing TEKNIX. We are sure you will find your new refrigerator a pleasure to use. However, before you use the appliance, we recommend that you carefully read the instructions, which provide details about installing and using the product. Please keep this manual for future reference.

Safety and warning information	01
Installing your new appliance.....	13
Reversing the door.....	15
Description of the appliance.....	19
Display control.....	20
Using your appliance.....	22
Cleaning and care.....	24
Helpful hints and tips.....	26
Troubleshooting.....	27
Disposal of the appliance.....	31
Product Dimension.....	34

Safety and warning information

For your safety and correct usage before installing and first using the appliance, read this user manual carefully, including its hints and warnings. To avoid unnecessary mistakes and accidents, it is important to make sure that all people using the appliance are thoroughly familiar with its operation and safety features. Save these instructions and be sure that they remain with the appliance if it is moved or sold, so that anyone using it throughout its life, will be properly informed on its usage and safety notices. For the safety of life and property, keep the precautions of these user's instructions as the manufacturer is not responsible for damages caused by omission.



Safety for children and others who are vulnerable people

According to EN standard

This appliance can be used by children aged from 8 years and above and persons with reduced physical, sensory or mental capabilities or lack of experience and knowledge if they have been given supervision or instruction concerning use of the appliance in a safe way and understand the hazards involved. Children shall not play with the appliance. Cleaning and user maintenance shall not be made by children without supervision.

Safety and warning information



Safety for children and others who are vulnerable people

According to IEC standard

This appliance is not intended for use by persons (including children) with reduced physical, sensory or mental capabilities, or lack of experience and knowledge, unless they have been given supervision or instruction concerning use of the appliance by a person responsible for their safety.

Keep all packaging away from children as there is risk of suffocation.

If you are discarding the appliance, pull the plug out of the socket, cut the connection cable (as close to the appliance as you can) and remove the door to prevent children playing from suffering an electric shock or from closing themselves inside it.

If this appliance, featuring a magnetic door seals, is to replace an older appliance having a spring lock (latch) on the door or lid, be sure to make the spring lock unusable before you discard the old appliance. This will prevent it from becoming a death trap for a child.

Safety and warning information



General safety

- **WARNING**

This appliance is intended to be used in household and similar applications such as 1.staff kitchen areas in shops, offices and other working environments; 2.farm houses and by clients in hotels, motels and other residential type environments;
3. bed and breakfast type environments;
4. catering and similar non-retail applications.

- **WARNING**

Fill with potable water only.

- **WARNING**

Do not store explosive substances such as aerosol cans with a flammable propellant in this appliance.

- **WARNING**

If the supply cord is damaged, it must be replaced by the manufacturer, its service agent or similarly qualified persons in order to avoid a hazard.

- **WARNING**

Keep ventilation openings, in the appliance enclosure or in the built-in structure, clear of obstruction.

Safety and warning information



General safety

- **WARNING**

Do not use mechanical devices or other means to accelerate the defrosting process, other than those recommended by the manufacturer.

- **WARNING**

Do not damage the refrigerant circuit.

- **WARNING**

Do not use electrical appliances inside the food storage compartments of the appliance, unless they are of the type recommended by the manufacturer.

- **WARNING**

The refrigerant and insulation blowing gas are flammable. When disposing of the appliance, do so only at an authorized waste disposal centre. Do not expose to flame.

- **WARNING**

When positioning the appliance, ensure the supply cord is not trapped or damaged.

Safety and warning information

General safety

- **WARNING**

Do not locate multiple portable socket-outlets or portable power supplies at the rear of the appliance.

Replacing the illuminating lamps

- **WARNING**

The illuminating lamps must not be replaced by the user! If the illuminating lamps is damaged, contact professional engineer for assistance. This warning is only for refrigerators that contain illuminating lamps.

Refrigerant

The refrigerant isobutene (R600a) is contained within the refrigerant circuit of the appliance, a natural gas with a high level of environmental compatibility, which is nevertheless flammable. During transportation and installation of the appliance, ensure that none of the components of the refrigerant circuit becomes damaged. The refrigerant (R600a) is flammable.

Safety and warning information

Refrigerant

- **WARNING**

Refrigerators contain refrigerant and gases in the insulation. Refrigerant and gases must be disposed of professionally as they may cause eye injuries or ignition. Ensure that tubing of the refrigerant circuit is not damaged prior to proper disposal.

- **WARNING**

Risk of fire / flammable materials If the refrigerant circuit should be damaged:

1. Avoid opening flames and sources of ignition.
2. Thoroughly ventilate the room in which the appliance is situated.

It is dangerous to alter the specifications or modify this product in any way. Any damage to the cord may cause a short circuit, fire, and/or electric shock.

Safety and warning information

Electrical safety

1. The power cord must not be lengthened.
2. Make sure that the power plug is not crushed or damaged. A crushed or damaged power plug may overheat and cause a fire.
3. Make sure that you can access the main plug of the appliance.
4. Do not pull the main cable.
5. If the power plug socket is loose, do not insert the power plug. There is a risk of electric shock or fire.
6. You must not operate the appliance without the interior lighting lamp cover.
7. The fridge is only applied with power supply of single phase alternating current of 220~240V/50Hz. If fluctuation of voltage in the district of user is so large that the voltage exceeds the above scope, for safety sake, be sure to apply A.C. Automatic voltage regulator of more than 350W to the fridge. The fridge must employ a special power socket instead of common one with other electric appliances. Its plug must match the socket with ground wire.

Safety and warning information

Daily use

- Do not store flammable gas or liquids in the appliance, There is a risk of an explosion.
- Do not operate any electrical appliances in the appliance (e.g. electric ice cream makers, mixers etc.).
- When unplugging always pull the plug from the mains socket, do not pull on the cable.
- Do not place hot items near the plastic components of this appliance.
- This refrigerating appliance is not intended to be used as a built-in appliance.
- Do not place food products directly against the air outlet on the rear wall.
- Store pre-packed frozen food in accordance with the frozen food manufacture's instructions.
- The appliances manufactures storage recommendations should be strictly adhered to. Refer to relevant instructions for storage.
- Do not place carbonated or fizzy drinks in the freezer compartment as it creates pressure on the container, which may cause it to explode, resulting in damage to the appliance.

Safety and warning information

- Do not place food products directly against the air outlet on the rear wall.
- Store pre-packed frozen food in accordance with the frozen food manufacturer's instructions.
- The appliances manufacturers storage recommendations should be strictly adhered to. Refer to relevant instructions for storage.
- Do not place carbonated or fizzy drinks in the freezer compartment as it creates pressure on the container, which may cause it to explode, resulting in damage to the appliance.
- Frozen food can cause frost burns if consumed straight from the freezer compartment.
- Do not place the appliance in direct sunlight.
- Keep burning candles, lamps and other items with naked flames away from the appliance so that do not set the appliance on fire.
- The appliance is intended for keeping food stuff and/or beverages in normal household as explained in this instruction booklet. The appliance is heavy. Care should be taken when moving it.
- Do not remove nor touch items from the freezer compartment if your hands are damp/wet, as this could cause skin abrasions or frost/freezer burns.
- Never use the base, drawers, doors etc. to stand on or as supports.

Safety and warning information

- Frozen food must not be refrozen once it has been thawed out.
- Do not consume ice popsicles or ice cubes straight from the freezer as this can cause freezer burn to the mouth and lips. ,
- To avoid items falling and causing injury or damage to the appliance, do not overload the door racks or put too much food in the crisper drawers.

Caution! Care and cleaning

- Before maintenance, switch off the appliance and disconnect the mains plug from the mains socket.
- Do not clean the appliance with metal objects, steam cleaner, ethereal oils, organic solvents or abrasive cleansers.
- Do not use sharp objects to remove frost from the appliance. Use a plastic scraper.

Safety and warning information

Installation Important

- For electrical connection carefully, follow the instructions given in this manual. Unpack the appliance and check if there are damages on it.
- Do not connect the appliance if it is damaged. Report possible damages immediately to the place you bought it. In this case retain packing.
- It is advisable to wait at least four hours before connecting the appliance to allow the oil to flow back in the compressor.
- Adequate air circulation should be around the appliance, lacking this leads to overheating. To achieve sufficient ventilation, follow the instructions relevant to installation.
- Wherever possible the back of the product should not be too close to a wall to avoid touching or catching warm parts (compressor, condenser) to prevent the risk of fire, follow the instructions relevant to installation.
- The appliance must not be locate close to radiators or cookers.
- Make sure that the mains plug is accessible after the installation of the appliance.

Safety and warning information

Service

- Any electrical work required to do the servicing of the appliance should be carried out by qualified electrician or competent person.
- This product must be serviced by an authorized Service Center, and only genuine spare parts must be used.
 1. If the appliance is Frost Free.
 2. If the appliance contains freezer compartment.



Children aged from 3 to 8 years are allowed to load and unload refrigerating appliances. (This clause applies only to the EU region.)

Installing your new appliance

Before using the appliance for the first time, you should be aware of the following tips.

Ventilation of appliance

In order to improve efficiency of the cooling system and save energy, it is necessary to maintain good ventilation around the appliance for the dissipation of heat. For this reason, sufficient clear space should be available around the refrigerator.

Suggest:

It is advisable for there to be 50–70mm of space from the back to the wall, at least 100mm from its top, at least 100mm from its side to the wall and a clear space upfront to allow the door to open 115°. Please refer to the diagrams below.

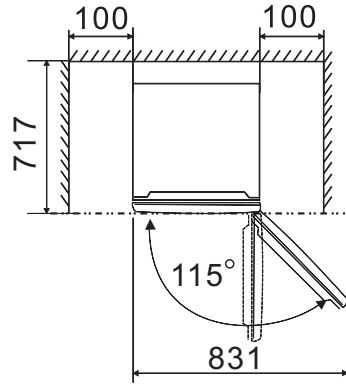
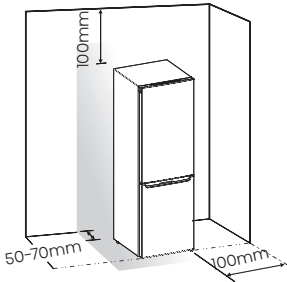

Note

This appliance performs well in the climate class from SN to ST. It may not work properly if being left at a temperature above or below the indicated range for a long period.

Climate class	Ambient temperature
SN	+10°C to +32°C
N	+16°C to +32°C
ST	+16°C to +38°C

Stand your appliance in a dry place to avoid high moisture damage. Keep the appliance out of direct sunlight, rain or frost. Stand the appliance away from heat sources such as stoves, fires or heaters.

Installing your new appliance

Leveling of appliance

- For sufficient leveling and air circulating in the lower rear section of the appliance, the bottom feet may need to be adjusted. Please use a suitable spanner.
- To allow the doors to self-close, tilt back the top backwards at about 15mm or 0.5 by turning the adjustable feet.
- Whenever you want to move the appliance, remember to turn the feet back up, so that the appliance can roll freely. Reinstall the appliance when relocating.

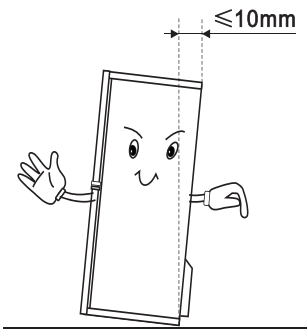





Reversing the door

The side at which the door opens can be changed, from the right side (as supplied) to the left side, if the installation site requires.

Warning!

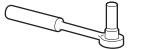
When reversing the door, the appliance must not be connected to the mains. Ensure that the plug is removed from the mains socket.

Tools you will need:

Not provided	
	
8mm socket wrench	Thin-blade screwdriver
	
Cross-shaped screwdriver	8mm wrench

When required, tilt the refrigerator back in order to gain access to the base, you should rest the appliance on soft foam packaging or similar material to avoid damaging the backboard of the refrigerator. To reverse the door, the following steps are generally recommended. Different models may correspond to different pictures. Models will be written in the picture. If some parts are not shown in the picture, please ignore the relevant description.

1. Stand the refrigerator upright. Open the upper door to take out all door racks (to avoid racks damaged) and then close the door.

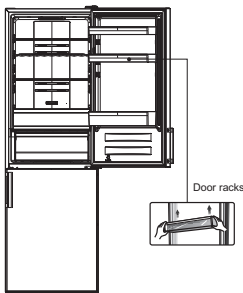

2. Remove part 1, loose part 2 from the top right side of refrigerator.

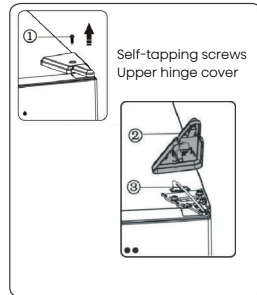

3. Remove screws 1 and hinge 2. When the refrigerator with display on door, you need to pass connector 3 through the hole of hinge 2. (Please hold upper door by hand when installing).

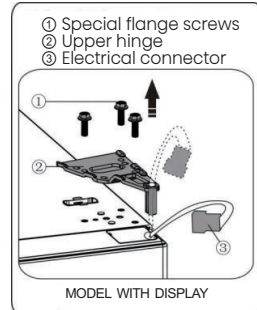
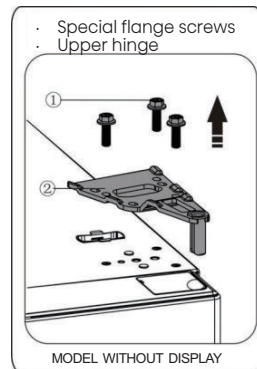

Reversing the door

4. Remove the upper door from the middle hinge by carefully lifting the door straight up. Then place the upper door on a smooth surface with its upper cover upwards.



5. When the refrigerator with a display on door, take screw hole cover (right) from plastic bag and install it onto the top right side of refrigerator body. Then remove screw hole cover (left) from the top left side of appliance and put it into plastic bag.

When the refrigerator without a display on door, pull out screw hole cover from the left side up rightly, and fix it on the right side.

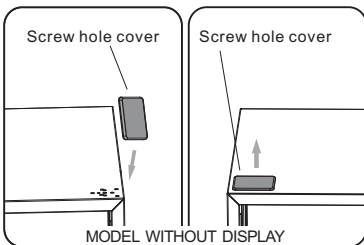
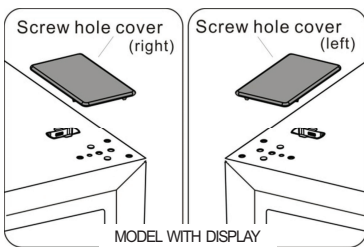

6. For the refrigerator is with a display on door, remove part 1 from the top left side of upper cover and take out part 2. Then remove part 3 and put part 4 into the top right side of upper cover. Refer to above operation, install part 3 and part 4 on to the top left side of upper cover. Install part 1 of the top right side of upper cover.

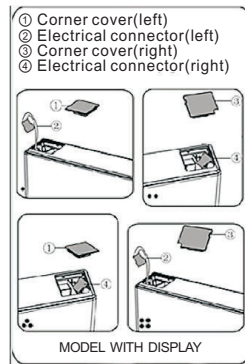

7. Loose screw 3 and take down part 2 and part 1, Install replacement door stopper-left 4 provided (in the plastic bag) and part 2 (stop block) to the left side with screw 3. Keep part 1 with the appliance for future reference.

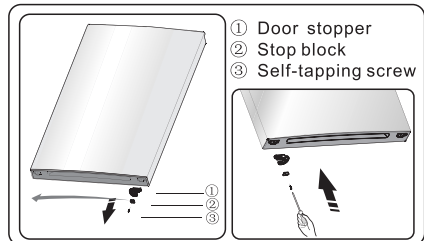

8. Loose screws used to fix the middle hinge and remove middle hinge. Then remove the lower door.

Reversing the door

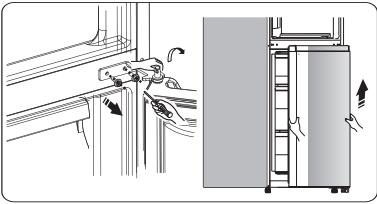

9. Place the lower door on a smooth surface with its panel upwards. Loose screw 3 and take down part 2 and part 1. Install replacement door stopper-left 4 provided (in the plastic bag) and part 2 (stop block) to the left side with screw 3. Keep part 1 with the appliance for future reference.

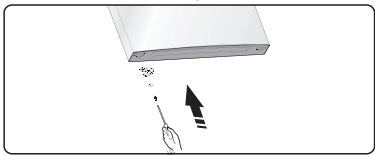
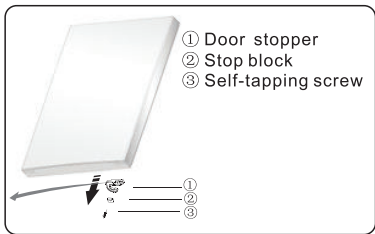

10. Change screw hole covers on middle cover plate from left to right (as shown in figure below).

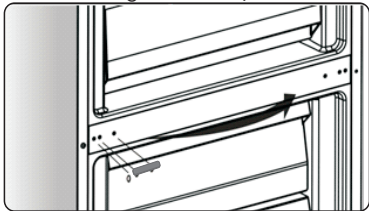

11. Tip the refrigerator backwards, remove part 2.

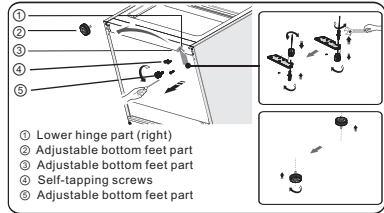

12. Remove part 3 from the lower hinge pin, loose out the lower hinge pin, change it to the reverse hole site, and then tighten into position, then install part 3 on the lower hinge pin.

13. Replace the items remount instep 11, change part to left, and then fix them with screws 4. Install part 2 at last.

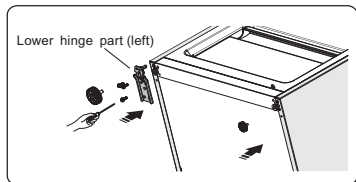

14. Slot the lower door onto the bottom hinge pin and hold in position. Turn the middle hinge by 180°, change the washer on the axis to the lower side, adjust the middle hinge to the appropriate position and then install it ensuring the lower door in secured place.

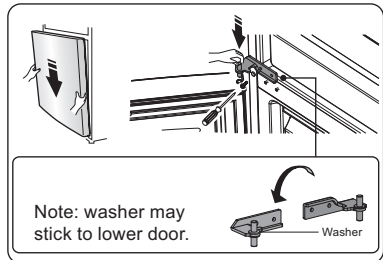

15. Move the upper door to an appropriate position, and then fix part 2 by screws 1. Before fix part 2, pass connector 3 through hinge 2 refer to step 3. (Please hold upper door by hand when installing.)

Reversing the door



- ① Special flange screws
- ② Upper hinge

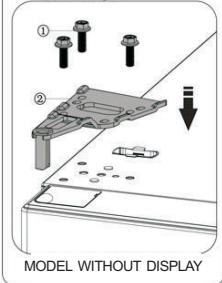

- ① Special flange screws
- ② Upper hinge
- ③ Electrical connector

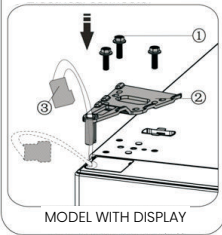

16. Connect electrical connector 1 as shown in the picture, then fix part 2 by screw 3, refer to step 2.

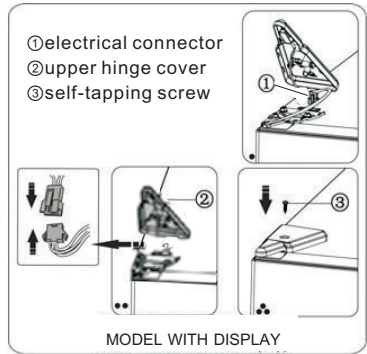

17. Open the upper door, mount door racks and then close it.

Note:

If your appliance has handle, you have to reverse handle by following instructions below.

Remove the upper door and place it on a smooth surface with its panel upwards. Lever part 1 and part 4, then loose screws 2, as shown in the picture. Change handle 3 to the right side, then install screws 2, part 1 and part 4 in turn.

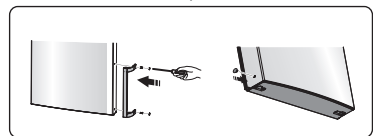
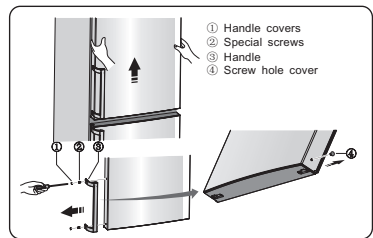

Description of the appliance

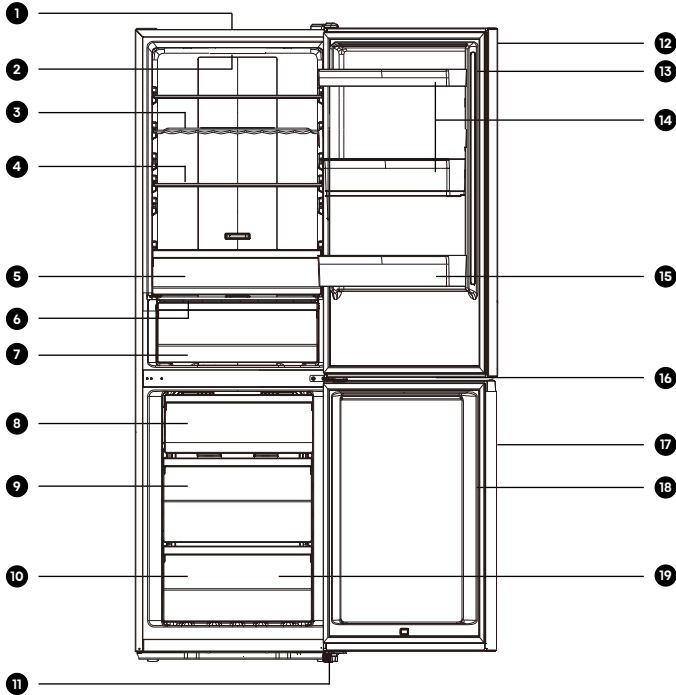

- | | |
|------------------|------------------------------|
| 1. Cabinet | 11. Adjustable feet |
| 2. LED light | 12. Refrigerator door |
| 3. Wine rack | 13. Refrigerator door gasket |
| 4. Glass shelves | 14. Upper rack (x2) |
| 5. Upper crisper | 15. Lower rack |
| 6. Crisper cover | 16. Handle |
| 7. Lower Crisper | 17. Freezer door |
| 8. Upper drawer | 18. Freezer door gasket |
| 9. Middle drawer | 19. Accessories |
| 10. Lower drawer | |

Note:

Due to unceasing modification of our products, some parts of your refrigerator may be slightly different from this instruction manual, but its functions and using methods remain the same.

To get more space in the freezer, you can remove drawers (except the bottom drawer in freezer). To get the best energy of this product, please place all shelves/drawers on their original position as the illustration above.

Display control

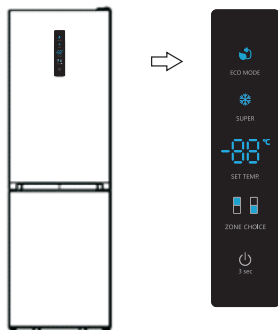

Display panel on door

Controlling the temperature

For optimum food preservation, We recommend that when you start your refrigerator for the first time, the temperature for the refrigerator is set to 4°C. If you want to change the temperature, follow the instructions below.

NOTE: High temperature setting will accelerate food waste.

Caution!

When you set a temperature, you set an average temperature for the whole refrigerator cabinet. Temperatures inside each compartment may vary from the temperature values displayed on the panel, depending on how much food you store and where you place them. Ambient temperature may also affect the actual temperature inside the appliance.

Fridge

● Press "ZONE CHOICE", the " " light will turn on. Then press "SETTEMP.", you can set fridge temperature between 2°C and 8°C as needed, and display panel will display corresponding values according to the following sequence.

8°C — 7°C — 6°C — 5°C
2°C — 3°C — 4°C

Freezer

Press "ZONE CHOICE", when the " " light turns on. Then press "SETTEMP.", you can set freezer temperature between -14°C and -24°C as needed, and the display panel will display corresponding value according to the following sequence.

-18°C — -19°C — -20°C — -21°C — -22°C — -23°C
-17°C — -16°C — -15°C — -14°C — -24°C

Super Freeze (❄)

Super Freeze will quickly lower the temperature within the freezer so food will freeze faster. This can lock in the vitamins and nutrients of fresh food and keep food fresh longer.

- You can press "SUPER" to get into super freezer mode.
- When super freeze Mode is selected, the light will be illuminated and the freezer temperature will be set at -24°C.
- In case of the maximum amount of food to be frozen, please wait about 24 h.
- Super freeze automatically switches off after 52 hours and then the freezer temperature setting will revert back to the previous setting.

Eco energy

This function makes the freezer work in a power saving mode which is useful for reducing energy consumption when you are away.

- You can press "ECO MODE" to get into economic energy mode.
- When economic energy Mode is activated, the light will be illuminated. The freezer temperature will be set at -17°C and the fridge temperature will be set at 6°C.

Display control

Switch

You can switch on or switch off your appliance by press this button.

- Press "  " for 3 seconds, after a buzzer sound, meanwhile the digital light will show "OF", the appliance will be turned off.

- Press "  " for 3 seconds, after a buzzer sound, the appliance will be turned on.

Alarm

- When the door of fridge has been opened for over 2 minutes, the door alarm will sound. In case of door alarm, buzzer will sound 3 times every 1 minute and will stop alarming automatically after 8 minutes.

- To save energy, please avoid keeping the door open for a long time when using the appliance. The door alarm can also be cleared by closing the door.

Using your appliance

Your appliance is supplied with a number of accessories and this section describes how best to use them.

Door rack

● It is suitable for the storage of eggs, canned liquid, bottled drinks and packed food, etc. Do not place too many heavy things in the racks.

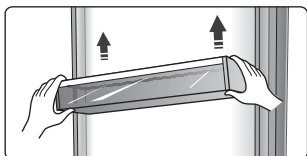

Shelf in Refrigerator chamber

● There are three shelves in refrigerator chamber, and they can be taken out to be cleaned.



Extra fresh box

● In certain model, there will be an extra fresh box(drawer). In this drawer you can get a lower temperature to store fish, meat and other erodible food temporarily. Normally it will be about 2°C lower than the other part of the fresh compartment. You can move the slide bar to set the temperature. There are some recommendations in the below table which you can consult.

fridge temp. set	slide bar	food	storage period
2°C	right most	fish&meat	<3 days
5°C	right most	fruit	<2 weeks
8°C	right most	vegetables	<5 days

Note:

Due to the environment temperature and setting temperature both influence the temperature of extra fresh box(drawer), the actual temperature may change in a certain range. The temperature of this drawer may lower than zero, so it is normal that liquid in this drawer was frozen.

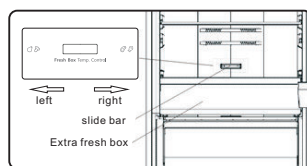

Flexible wine rack

● It is for storing bottled wine or drinks, and it can be taken out to clean.

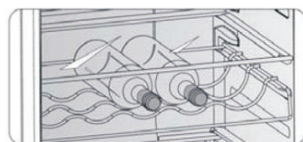

Crisper cover

● It is for controlling the temperature of the crisper and avoiding the vegetable losing moisture.

● You can adjust the slide bar on the crisper cover to keep different humidity in the crisper. Push the slide bar to the left, you will keep a higher humidity which can storage vegetable and fruit long and fresh, to the right will be lower humidity.



slide bar

crisper cover

Fruit and vegetable crisper

● It is suitable for the storage of fruits and vegetable.

Using your appliance

Freezer Drawer

● It is used to store food which needs to be frozen, including meat, fish, ice cream, etc.

Ice cube tray

● It is used to make ice cubes. To make ice cubes, please fill water into the ice cube trays and the water level shall not exceed the top line (ideally eighty percent of the ice tray volume). Place the tray into the freezer drawer and wait at least two hours for the ice cubes to be formed. After the cubes are formed, gently twist the tray to separate the cubes and trays.



Cleaning and care

- For hygienic reasons the appliance (including exterior and interior accessories) should be cleaned regularly (at least every two months).



Warning

- The appliance must not be connected to the mains during cleaning. Danger of electrical shock! Before cleaning switch the appliance off and remove the plug from the mains socket.

Exterior cleaning

To maintain good appearance of your appliance, you should clean it regularly.

- Wipe the digital panel and display panel with a clean, soft cloth.
- Spray water onto the cleaning cloth instead of spraying directly on the surface of the appliance. This helps ensure an even distribution of moisture to the surface.
- Clean the doors, handles and cabinet surfaces with a mild detergent and then wiped dry with a soft cloth.

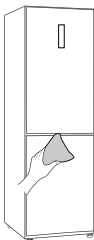

Warning

- Do not use sharp objects as they are likely to scratch the surface. Do not use Thinner, Car detergent
- Clorox, ethereal oil, abrasive cleansers or organic solvent such as Benzene for cleaning. They may damage the surface of the appliance and may cause fire.

Interior cleaning

- You should clean the appliance interior regularly. It will be easier to clean when food stocks are low. You can remove the drawers and shelves for a more thorough clean.
- Wipe the inside of the freezer with a weak solution of bicarbonate of soda, and then rinse with warm water using a wrung-out sponge or cloth. Wipe completely dry before replacing the shelves and baskets.
- Thoroughly dry all surfaces and removable parts before putting them back into place.
- Although this appliance automatically defrosts, a layer of frost may occur on the freezer compartment's interior walls if the freezer door is opened frequently or kept open too long.

Cleaning and care

- If the frost is too thick, choose a time when the freezer is nearly empty and proceed as follow:
 1. Remove existing food and accessories baskets, unplug the appliance from the mains power and leave the doors open. Ventilate the room thoroughly to accelerate the process.
 2. When defrosting is completed, clean your freezer as described above.



Warning

- Do not use sharp objects to remove frost from the freezer compartment.
- Only after the interior is completely dry should the appliance be switched back on and plugged back into the mains socket.

Door seals cleaning

- Take care to keep door seals clean. Sticky food and drinks can cause seals to stick to the cabinet and tear when you open the door. Wash the seals with a mild detergent and warm water. Rinse and dry them thoroughly after cleaning.

Helpful hints and tips

Energy saving tips

- We recommend that you follow the tips to save energy.
- Try to avoid keeping the door open for long periods in order to conserve energy.
 - Ensure the appliance is away from any sources of heat (Direct sunlight, electric oven or cooker etc.)
 - Don't set the temperature colder than necessary.
 - Don't store warm food or evaporating liquid in the appliance.
 - Place the appliance in a well ventilated, humidity free room. Please refer to the installing your new appliance chapter.
 - The description of appliance diagram shows the correct combination for the drawers, crisper and shelves, do not adjust the combination as this is designed to be the most energy efficient configuration.

Hints for fresh food refrigeration

- Do not place hot food directly into the refrigerator or freezer, the internal temperature will increase resulting in the compressor having to work harder and will consume more energy.
- Do cover or wrap the food, particularly if it has a strong flavor.
- Place food properly so that air can circulate freely around it.

Hints for refrigeration

- Meat (all Types) Wrap in polythene food: wrap and place on the glass shelf above the vegetable drawer. Always follow food storage times and use by dates suggested by manufacturers.
- Cooked food, cold dishes, etc: They should be covered and may be placed on any shelf.
- Fruit and vegetables: They should be stored in the special drawer provided.
- Butter and cheese: Should be wrapped in airtight foil or plastic film wrap.
- Milk bottles: Should have a lid and be stored in the door racks.

Hints for freezing

- When first starting-up or after a period out of use, let the appliance run at least 2 hours on the higher settings before putting food in the compartment.
- Prepare food in small portions to enable it to be rapidly and completely frozen and make it possible to subsequently thaw only the quantity required.
- Wrap up the food in aluminum foil or polyethylene food wraps which are airtight.
- Do not allow fresh, unfrozen food to touch the food which is already frozen to avoid partial defrosting.

Helpful hints and tips

- It is recommended to label and date each frozen package in order to keep track of the storage time.

Hints for fresh food refrigeration

- Ensure that frozen food has been stored correctly by the food retailer .
- Once defrosted, food will deteriorate rapidly and should not be re-frozen.
- Do not exceed the storage period indicated by the food manufacturer.

Switching off your appliance

- If the appliance needs to be switched off for an extended period, the following steps should be taken to prevent mould on the appliance.
 1. Remove all food.
 2. Remove the power plug from the mains socket.
 3. Clean and dry the interior thoroughly.
 4. Ensure that all the doors are wedged open slightly to allow air to circulate.

Troubleshooting

If you experience a problem with your appliance or are concerned that the appliance is not functioning correctly, you can carry out some easy checks before calling for service, please see below. You can carry out some easy checks according to this section before calling for service.



Warning

Don't try to repair the appliance yourself. If the problem persists after you have made the checks mentioned below, contact a qualified electrician, authorized service engineer or the shop where you purchased the product.

Problem	Possible cause & Solution
Appliance is not working correctly	Check whether the power cord is plugged into the power outlet properly.
	Check the fuse or circuit of your power supply, replace if necessary.

Troubleshooting

Problem	Possible cause & Solution
Appliance is not working correctly	The ambient temperature is too low. Try setting the chamber temperature to a colder level to solve this problem.
	It is normal that the refrigerator is not operating during the automatic defrost cycle, or for a short time after the appliance is switched on to protect the compressor.
Odours from the compartments	The interior may need to be cleaned.
	Some food, containers or wrapping cause odours.
Noise from the appliance	<p>The sounds below are quite normal:</p> <ul style="list-style-type: none"> • Compressor running noises. • Air movement noise from the small fan motor in the freezer compartment or other compartments. • Gurgling sound similar to water boiling. Popping noise during automatic defrosting. • Clicking noise before the compressor starts.
	<p>Other unusual noises are due to the reasons below and may need you to check and take action:</p> <ul style="list-style-type: none"> • The cabinet is not level. • The back of appliance touches the wall. • Bottles or containers knocking against each other.
The motor runs continuously	<p>It is normal to frequently hear the sound of the motor, it will need to run more when in following circumstances:</p> <ul style="list-style-type: none"> • Temperature setting is set colder than necessary. • Large quantity of warm food has recently been stored within the appliance. • The temperature outside the appliance is too high. • Doors are kept open too long or too often. • After your installing the appliance or it has been switched off for a long time.

Troubleshooting

Problem	Possible cause & Solution
A layer of frost occurs in the compartment	<p>Check that the air outlets are not blocked by food and ensure food is placed within the appliance to allow sufficient ventilation.</p> <ul style="list-style-type: none"> • Ensure the door can be fully closed . To remove the frost, please refer to the cleaning and care chapter.
Temperature inside is too warm	<p>You may have left the doors open too long or too frequently;</p> <ul style="list-style-type: none"> • Or the doors are kept open by some obstacle; • Or the appliance is located with insufficient clearance at the sides, back and top.
Temperature inside is too cold	<p>Increase the temperature by following the “Display controls” chapter.</p>
Doors can't be closed easily	<p>Check whether the top of the refrigerator is tilted back by 10-15mm to allow the doors to self close, or if something inside is preventing the doors from closing.</p>
Water drips on the floor	<p>The water pan (located at the rear bottom of the cabinet) may not be properly leveled, or the draining spout underneath the top of the compressor depot may not be properly positioned to direct water into this pan, or the water spout is blocked , or the water is not fully inserted into the connector.</p> <ul style="list-style-type: none"> • You may need to pull the refrigerator away from the wall to check the pan and spout and connector. • Check if the refrigerator is power-off for a long time, this may cause the ice in the bucket to melt into water, and flow to the floor.
The light is not working	<ul style="list-style-type: none"> • The LED light may be damaged. Refer to replace LED lights in cleaning and care chapter. • The control system has disabled the lights due to the door being kept open too long, close and reopen the door to reactivate the lights.

Troubleshooting

Problem	Possible cause & Solution
Ice is not dispensing	<ul style="list-style-type: none">• Did you wait for 10 hours after installation of the water supply line before making ice? if it is not sufficiently cool, it may take longer to make ice, such as when first installed.• Is the water line connected and the water valve open?• Did you manually stop the ice making function? Make sure you have set the Cubed or Crushed mode on.• Is there any ice blocked within the ice maker bucket or ice chute?• Is the freezer temperature too warm? Try setting the freezer temperature lower.
Water dispenser is not functioning	<ul style="list-style-type: none">• Is the water storage box installed accurately? Make sure there is enough water in the water storage box.• Is water line broke or bent? Make sure the water line is unblocked and clear of any obstruction.• Is the water storage box frozen for the refrigerator temperature is too low? Try selecting a warmer setting on the display panel.• Is the water pump working?
You can hear water bubbling in the refrigerator	<ul style="list-style-type: none">• This is normal. The bubbling comes from the refrigerant coolant liquid circulating through the refrigerator.

Disposal of the appliance

It is prohibited to dispose of this appliance as household waste.

Packaging materials

Packaging materials with the recycle symbol are recyclable. Dispose of the packaging into a suitable waste collection container to recycle it.

Before disposal of the appliance

1. Pull out the mains plug from the mains socket.
2. Cut off the power cord and discard with the mains plug



Warning

Refrigerators contain refrigerant and gases in the insulation. Refrigerant and gases must be disposed of professionally as they may cause eye injuries or ignition. Ensure that tubing of the refrigerant circuit is not damaged prior to proper disposal.

Correct Disposal of this product	
	<p>This marking indicates that this product should not be disposed of with other household wastes throughout the EU. To prevent possible harm to the environment or human health from uncontrolled waste disposal, recycle it responsibly to promote the sustainable reuse of material resources. To return your used device, please use the return and collection systems or contact the retailer where the product was purchased. They can take this product for environmental safe recycling.</p>

Disposal of the appliance

To avoid contamination of food, please respect the following instructions

- Opening the door for long periods can cause a significant increase of the temperature in the compartments of the appliance.
- Clean regularly surfaces that can come in contact with food and accessible drainage systems.
- Store raw meat and fish in suitable containers in the refrigerator, so that it is not in contact with or drip onto other food.
- Two-star frozen-food compartments are suitable for storing pre-frozen food, storing or making ice cream and making ice cubes.
- One-, two- and three-star compartments are not suitable for the freezing of fresh food.

Order	Compartments type	Target storage temp.[°C]	Appropriate food
1	Fridge	+2~+8	Eggs, cooked food, packaged food, fruits and vegetables, dairy products, cakes, drinks and other foods which are not suitable for freezing.
2	(***)*-Freezer	≤-18	Seafood (fish, shrimp, shellfish), freshwater aquatic products and meat products (recommended for 3 months, the longer the storage time, the worse the taste and nutrition), suitable for frozen fresh food.
3	***-Freezer	≤-18	Seafood (fish, shrimp, shellfish), freshwater aquatic products and meat products (recommended for 3 months, the longer the storage time, the worse the taste and nutrition), are not suitable for frozen fresh food.
4	Wine	+5~+20	Red wine, white wine, sparkling wine etc.

Disposal of the appliance

Order	Compartments type	Target storage temp.[°C]	Appropriate food
5	**-Freezer	≤-12	Seafood (fish, shrimp, shellfish), freshwater aquatic products and meat products (recommended for 2 months, the longer the storage time, the worse the taste and nutrition), are not suitable for frozen fresh food.
6	*-Freezer	≤-6	Seafood (fish, shrimp, shellfish), freshwater aquatic products and meat products (recommended for 1 month, the longer the storage time, the worse the taste and nutrition), are not suitable for frozen fresh food.
7	0-star	-6~0	Fresh pork, beef, fish, chicken, some packaged processed foods, etc. (Recommended to eat within the same day, preferably not later than 3 days). Partially packed/wrapped up encapsulated processed foods (non-freezable foods).
8	chill	-2~+3	Fresh/frozen pork, beef, chicken, freshwater aquatic products, etc.(7 days below 0 °C and above 0 °C is recommended for consumption within that day, preferably no more than 2 days). Seafood (less than 0°C for 15 days, it is not recommended to store above 0°C).
9	Fresh Food	0~+4	Fresh pork, beef, fish, chicken, cooked food, etc. (Recommended to eat within the same day, preferably no more than 3 days).

Disposal of the appliance



Note

please store different foods according to the compartments or target storage temperature of your purchased products.

- If the refrigerating appliance is left empty for long periods, switch off, defrost, clean, dry, and leave the door open to prevent mould developing within the appliance.

Water dispenser cleaning (special for water dispenser products):

- Clean water tanks if they have not been used for 48 h; flush the water system connected to a water supply if water has not been drawn for 5 days.



Warning

Food needs to be packed in bags before putting into the refrigerator, and liquids need to be packed in bottles or capped containers to avoid the problem that the product design structure is not easy to clean.

Product Dimension

Product dimension (H*W*D mm)	1860*595*590
Packing dimension (H*W*D mm)	1935*645*628

This product contains a light source of energy efficiency class F.
For product with light, light source is replaceable only by qualified engineers.

We, Teknix, undertake that if within 24 months of the date of purchase this appliance or any part thereof is proven to be defective by reason of mechanical or electrical failure we will at our discretion repair or replace the same free of any charge for labour, materials or carriage on condition that:

- The appliance has been correctly installed in accordance to manufacturers' instructions.
- The appliance has been used for normal domestic purposes only and in accordance with our operating instructions.
- The appliance has not been repaired, taken apart or tampered with by any person not authorized by us.
- All repair work under this guarantee must be undertaken by the organization or its authorized agents
- Proof of purchase is available on request
- If we decide your appliance cannot be repaired, or is uneconomical to repair, we'll replace it with the same model. If that model is no longer available, we'll discuss an alternative settlement with you.
- We reserve the right to charge for the expense of a service call if no fault has been found with the appliance after we have inspected it.
- All claims must be arranged via a call to us on 01759 487893. Without pre-authorisation it may result in the cost of claim not being reimbursed.

This guarantee is in addition to your statutory and other legal right.

Exclusions

- Damage resulting from transportation, improper use, or neglect.
- Appliance outside the United Kingdom.
- Cosmetic damage and/or non-functional parts, which do not affect the normal use of the product including for example cabinet, scratches and rust.
- Any loss suffered as a result of not being able to use the appliance or any loss other than the repair or the replacement cost of the product.
- Accidental or physical damage.



Your Teknix appliance comes with a 2 year parts
and labour guarantee

Please REGISTER your appliance on line at

www.teknixwarranty.co.uk

You also have the option to EXTEND YOUR WARRANTY To
5 years parts and labour

To register your appliance or extend your warranty

Please call **01759 487823**
