

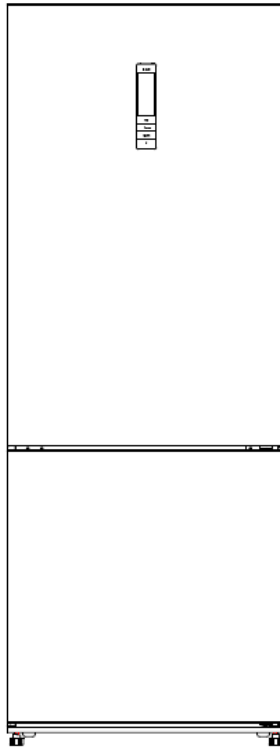

## REFRIGERATOR INSTRUCTION MANUAL

Model No.: FF1857B  
FF1857W  
FF1857S



Dear users, this manual contains the product's basic knowledge, how to use it, fault diagnosis and basic troubleshooting methods. In order to better understand and use this product, please take good care of this manual and read it carefully.

# Contents

I.	Safety Instructions	4
II.	Product Features	8
III.	Preparations for Use	10
IV.	Functions	12
V.	Instructions For Food Storage	16
VI.	Maintenance and Cleaning	19
VII.	Troubleshooting	21
VIII.	Reversing the Door	23
IX.	Certifications	26
X.	Product Support	27
XI.	Guarantee	28

\* Varying with Different Products

# I. SAFETY INSTRUCTIONS

 **WARNING:** It is hazardous for anyone other than authorised service personnel to carry out servicing or repairs which involves the removal of covers. To avoid the risk of an electric shock, do not attempt to repair this appliance yourself.



**WARNING:** Risk of fire / flammable materials.

## Safety Warnings and Information

**WARNING:** Do not use electrical appliances such as a hair dryer or heater to defrost your Freezer.

**WARNING:** Containers with flammable gases or liquids can leak at low temperatures.

**WARNING:** Do not store any containers with flammable materials, such as spray cans, fire extinguisher, refill cartridges etc. in the Freezer.

**WARNING:** Do not place carbonated or fizzy drinks in the Freezer compartment. Ice lollies can cause "Frost/Freeze burns" if consumed straight from the Freezer.

**WARNING:** Do not remove items from the Freezer compartment if your hands are damp/wet, as this could cause skin abrasions or "Frost/Freezer burns". Bottles and cans must not be placed in the Freezer compartment as they can burst when the contents freeze.

**WARNING:** Manufacturer's recommended storage times should be adhered to. Refer to relevant instructions.

**WARNING:** Do not allow children to tamper with the controls or play with the appliance.

**IMPORTANT:** The appliance is heavy. Care should be taken when moving it. It is dangerous to alter the specification or attempt to modify this product in any way.

**WARNING:** Do not store flammable gases or liquids inside your Freezer.

**IMPORTANT:** If the power cable is damaged, it must be replaced by the manufacturer, its service agent or similarly qualified persons in order to avoid a hazard.

**WARNING:** This appliance can be used by children aged from 8 years and above and persons with reduced physical, sensory or mental capabilities or lack of experience and knowledge, if they have been given supervision or instruction concerning use of the appliance in a safe way and understand the hazards involved. Children shall not play with the appliance. Cleaning and user maintenance shall not be made by children without supervision.

**IMPORTANT:** This appliance is intended to be used in household and similar applications such as

- staff kitchen areas in shops, offices and other working environments,
  - farm houses and by clients in hotels, motels and other residential type environments,
  - bed and breakfast type environments,
  - catering and similar non-retail applications.
- Keep ventilation openings, in the appliance enclosure or in the built-in structure, clear of obstruction.
  - Do not use mechanical devices or other means to accelerate the defrosting process, other than those recommended by the manufacturer.
  - Do not damage the refrigerant circuit.
  - Do not use electrical appliances inside the food storage compartments of the appliance,

unless they are recommended by the manufacturer.

- Do not store explosive substances such as aerosol cans with a flammable propellant in this appliance.
- This appliance is not intended for use by persons (including children) with reduced physical, sensory or mental capabilities, or lack of experience and knowledge, unless they have been given supervision or instruction concerning use of the appliance by a person responsible for their safety. Children should be supervised to ensure that they do not play with the appliance.

**IMPORTANT:** Keep ventilation openings in the appliance enclosure or in the built-in structure, clear of obstruction.

**WARNING:** Do not use mechanical devices or other means to accelerate the defrosting process, other than those recommended by the manufacturer.

**WARNING:** Do not damage the refrigerant circuit.

**WARNING:** Do not use electrical appliances inside the food storage compartments of the appliance, unless they are of the type recommended by the manufacturer.

**WARNING:** Refrigerating appliances, in particular a refrigerator-freezer, might not operate consistently (possibility of defrosting of contents or temperature becoming too warm in the frozen food compartment), when appliance is running for an extended period of time, below the cold end of the range of temperatures for which the refrigerating appliance is designed.

**WARNING:** It is necessary that, for doors or lids fitted with locks and keys, the keys be kept out of the reach of children and not in the vicinity of the refrigerating appliance, in order to prevent children from being locked inside.

**WARNING:** The refrigerant used in your appliance and insulation materials requires special disposal procedures.

**WARNING:** When positioning the appliance, ensure the supply cord is not trapped or damaged.

**WARNING:** Do not locate multiple portable socket-outlets or portable power supplies at the rear of the appliance

Children aged from 3 to 8 years are allowed to load and unload refrigerating appliances.



To avoid contamination of food, please adhere to the following instructions:

- Opening the door for long periods can cause a significant increase of the temperature in the compartments of the appliance.
- Clean regularly surfaces that can come in contact with food and have accessible drainage systems.
- Clean water tanks if they have not been used for 48 hours, flush the water system connected to a water supply if water has not been used for 5 days.
- Store raw meat and fish in suitable containers in the refrigerator, so that it is not in contact with or drip onto other food.
- Two-star frozen food compartments are suitable for storing pre-frozen food, storing or making ice-cream and making ice cubes.
- One, two and three-star compartments are not suitable for the freezing of fresh food.
- If the refrigerating appliance is left empty for long periods of time, switch off, defrost, clean, dry, and leave the door open to prevent mould developing within the appliance.

## Electrical Supply Connection

- Connect the appliance to the electrical supply (220-240 V ~ 50 Hz) with the plug and lead, which are fitted.
- Connections to the mains supply should be in accordance with local regulations.
- DO NOT use plug adapter.
- The appliance must be plugged into an earthed socket
- Always make sure that the plug is accessible after the appliance has been positioned.
- If the electrical cable is damaged or worn, turn off the refrigerator and consult an authorised agent for replacement.

## Electrical Safety

- ⚡  **WARNING:** When positioning the appliance, ensure the supply cord is not trapped or damaged.
- ⚡  **WARNING:** DO NOT locate multiple portable socket- outlets or portable power supplies at the rear of the appliance  
DO NOT use plug adapter.
- ⚡  **WARNING:** Risk of fire / flammable materials

- The plug must be accessible after installation.
- The operating voltage for your appliance is 220-240 V at 50Hz.
- Connections to the mains supply should be in accordance with local regulations.
- Insert the plug into a socket with an efficient ground connection. If the socket has no ground contact or the plug does not match, we recommend you consult a qualified electrician for assistance.
- The appliance must be connected with a properly installed fused socket. The power supply (AC) and voltage at the operating point must match with the details on the name plate of the appliance (the name plate is located on the inside left of the appliance).
- The appliance must be plugged into an earthed socket.
- The plug **MUST** be accessible after the appliance has been positioned. The cord should be secured and not left exposed or dangling to prevent accidental injury.
- The appliance is supplied with a standard three-pin plug, of which the one for grounding should never be removed.
- Hold the plug, not the electrical cable, when unplugging the appliance.
- Make sure that the appliance does not trap the electric cable.
- DO NOT step on the cable.
- Avoid damage to the electric cable when moving the appliance.
- This refrigerator appliance is not designed to be used with an inverter.

DO NOT use an extension cord with this appliance. If the power cord is too short, have a qualified electrician or service technician install an outlet near the appliance. Use of an extension cord can negatively affect the performance of the unit.

**WARNING:** Improper use of the grounded plug can result in the risk of electrical shock. If the power cord is damaged, have it replaced by an authorised service provider.

## Climate Range

The information about the climate range of the appliance is provided on the rated plate. It indicates at which ambient temperature (that is, the room temperature in which the appliance is working) the operation of the appliance is optimal (proper).

Climate range	Permissible ambient temperature
SN	from +10°C to +32°C
N	from +16°C to +32°C
ST	from +16°C to +38°C
T	from +16°C to +43°C

Note: Given the limit values of the ambient temperature range for the climate classes for which the refrigerating appliance is designed, and the fact that the internal temperatures could be affected by such factors as location of the refrigerating appliance, ambient temperature and the frequency of door opening, the setting of any temperature control device might have to be varied to allow for these factors, if appropriate.

## Freon-free

The freon-free refrigerant (R600a) and the foaming insulation material (cyclopentane) are used for this refrigerator and are environmentally friendly, causing no damage to the ozone layer and having very small impact on global warming. R600a is flammable, and sealed in a refrigeration system, without leakage during normal use. In the case of refrigerant leakage due to the refrigerant circuit being damaged, be sure to keep the appliance away from open flames and open the windows for ventilation as quickly as possible.

## II. Product Features

This fridge-freezer is equipped with electronic controls. Its top compartment for fresh food storage, such as fruits, vegetables, eggs, milk, cooked foods, etc.; and its bottom freezer compartment where fish, meat, etc. can be frozen for long-term storage.

- **Display**

Within the cabinet of the fridge compartment is an electronic temperature control panel. This is used to control the temperature/mode of your fridge/freezer.

- **Green technology**

The freon-free refrigerant and foaming insulation materials are used for this fridge-freezer, causing no damage to the ozone layer and having a very small impact on global warming, therefore the fridge is an environmentally friendly product.

- **Frost Free with multi air flow**

You will never have to worry about manual defrosting as frost free technology constantly circulates cold air inside to stop icy build up. The warm air that enters your freezer each time you open the door gets removed thanks to an automatic fan.

- **Interior LED Lighting**

Your fridge/freezer comes equipped with an energy efficient LED internal light which holds a longer service life.

- **Reversible Doors**

The doors of the fridge/freezer have been designed to have the ability to be hinged from either the right or left side. (Instructions on how to reverse the door can be found on pages 19–21).

- **User-friendly designs**

Such functions as wide working voltage range, automatic temperature control, power-off memory, power-on delay, automatic alarm, fast freezing, and fridge power-off, etc. are the reasons that make this refrigerator easy and efficient to use.

## Refrigerator Diagram

Note: Due to technological innovation, the product descriptions in this manual may not be completely consistent with your refrigerator. Details are in accordance with the real product.

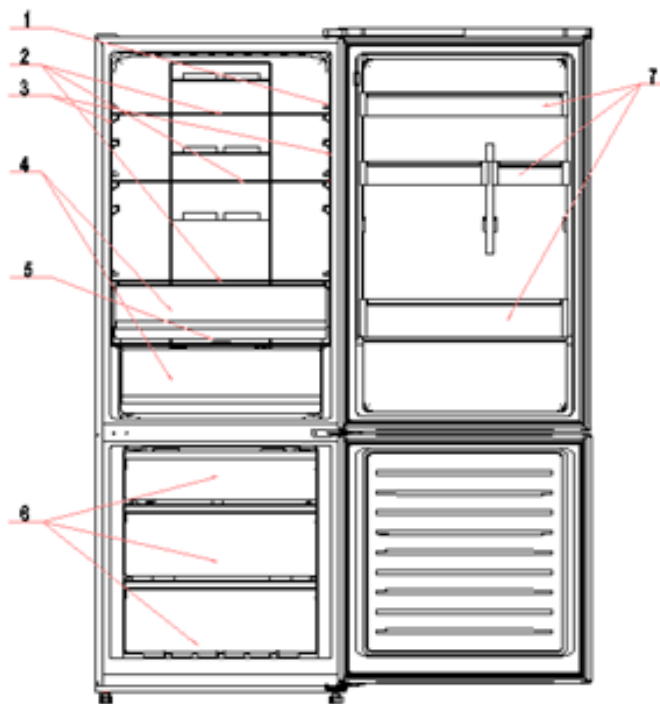

No	Description
1	Light switch
2	Fridge shelves
3	Light
4	Crisper box
5	Crisper box cover
6	Freezer drawers
7	Door balcony



### III. Preparations for use

#### Installation location:

##### 1. Ventilation condition

When installing your refrigerator, ensure it is in a well ventilated location. Do not install the refrigerator near any heat source such as a cooker. Avoid locating the refrigerator in direct sunlight, this will ensure you reduce the energy consumption of the appliance. Do not locate the refrigerator in a damp place, this will prevent the refrigerator from rusting and leaking electricity.

The result of the total space of the room in which the refrigerator is installed being divided by the refrigerant charge amount of the refrigerator shall not be less than 8 g/ M3.

Note: The amount of refrigerant charged for the refrigerator can be found on the nameplate.

##### 2. Heat dissipation space

When your refrigeration is installed and running, it will give off heat to it's surroundings. Therefore, a minimum of 300mm free space should be at the top of the unit, minimum of 100mm on both sides, and a minimum of 50mm at the back of the refrigerator.

Dimensions in mm:

W	D	H	A	B	C(°)	E	F
703	703	1855	1165	1360	125±5	50	100



Fig. 1

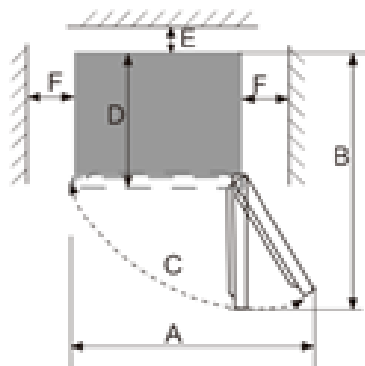

Fig. 2

Note: Figure 1, Figure 2 only illustrate the space demand of the product.

### 3. Level ground

Place the refrigerator on a solid and flat ground (floor) to keep it stable, or else it will give rise to vibration and noise.



Unobstructed ventilation shall be maintained around the appliance or in an embedded structure.

## Preparations for use

### 1. Standing time

After the refrigerator is properly installed and well cleaned, do not switch it on immediately. Make sure you allow a minimum of 4 hours before turning on the power of the refrigerator.

### 2. Cleaning

Before use ensure you clean the internal compartments and all shelves and accessories with a soft cloth.

### 3. Power-on

Insert the plug into the power socket to start the compressor. After 1 hour, open the freezer door, if the temperature inside the freezer compartment drops obviously, it indicates the refrigeration system is working normally.

### 4. Storage of food

After the refrigerator runs for a period of time, the internal temperature of the refrigerator will be automatically controlled according to the user's temperature setting. After the refrigerator is fully cooled, put in foods, which usually need 2~3 hours to be fully cooled. In summer, when the temperature is high, it takes more than 4 hours for the foods to be fully cooled (Try to open the refrigerator door as less as possible before the internal temperature cools down).

If the refrigerator is installed in a moisture filled room, make sure to check whether the ground wire and leakage circuit breaker are normal. If vibration noises are produced due to the refrigerator making contact with the wall, or if the wall gets blackened by air convection around the compressor, move the refrigerator away from the wall. Setting up the refrigerator may cause jamming noise or image chaos to mobile phones, fixed-line telephone, radio receiver, television sets surrounding it, so try to keep the refrigerator as far away as possible from these items.

## IV. Functions

The display panel is designed on the fridge door, illustrated as the figures below:

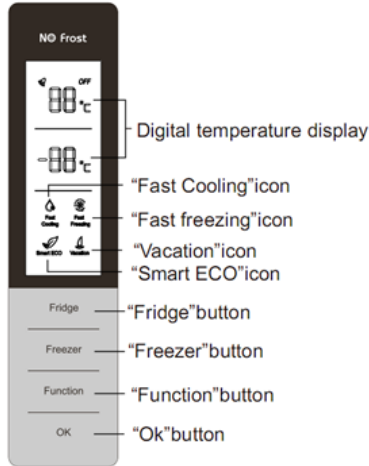

### Function Setting

When the refrigerator system is connected to the power supply for the first time, all icons on the display panel illuminate for 2 seconds, and the system will run in the Smart Mode by default. When all the doors are closed, if no key is used for 3 minutes the light on display will automatically turn off. The display will light up if any door is opened or any key is pressed.

The following key operations are valid only when the keys are unlocked and gets illuminated on the display.

### Temperature Setting

#### 1. Fridge temperature setting:

Press the Temp. Zone key to select the either the Fridge zone until the corresponding icon flickers, then press the Temp. key to set the temperature as desired. Press the OK key or wait for 5 seconds to validate the setting.

The fridge temperature setting cycles as following:

5→6→7→8→OFF→2→3→4→5

OFF indicates the fridge is switched off, and when the OFF function takes effect, the fridge will stop cooling.

**Be sure to take all foods out of the fridge compartment before setting this function.**

## 2. Freezer temperature setting

Press the Temp. Zone key to select the Freezer zone until the corresponding icon flickers, then press the Temp. key to set the temperature as desired. Press the OK key or wait for 5 seconds to validate the setting.

The freezer temperature setting cycles are as following:

-18 > -17 > -16 > -24 > -23 > -22 > -21 > -20 > -19 > -18

## 3. Holiday

 **When the Holiday function is enabled, the freezer temperature will be controlled at 14°C.**

- When you are out for a long time, you can set the Holiday function to keep the refrigerator running with low energy consumption, while ensuring the fresh food compartment is free from undesirable smells and the freezer compartment operates normally.



 **Be sure to take out all foods from the fresh food compartment before setting this function.**

**Under the Holiday mode, the fridge temperature is subject to no change.**

- Enabling the Holiday function  
Press the Function key to select Holiday until the corresponding icon flickers, and then press the OK/Lock key within 5 seconds for confirmation. If the OK/Lock is not pressed within 5 seconds, the setting will be invalidated.
- Exiting the Holiday function  
Under the Holiday mode, press the Function key to select Holiday until the corresponding icon flickers, and then press the OK/Lock key for confirmation. The Holiday function will then be exited.

**When the Smart function is enabled, the Holiday function will be disabled automatically.**

## 4. Fast Cooling

When the fast cooling function is enabled, temperature will be set at 2°C, with the compartment temperature reduced rapidly, so that foods can be kept in fresh condition with their nutrition not lost.

 **Under the 'Fast Cooling' mode, the compartment temperature is subjected to no change.**

Enabling the Fast Cooling function:

- Press the Function key to select Fast Cooling until the corresponding icon flickers, and then press the OK/Lock key within 5 seconds for confirmation. If the OK/Lock key is not pressed within 5 seconds, the setting will be invalidated.

Exiting the Fast Cooling function

- Under the Fast Cooling mode, press the Function key to select Fast Cooling until the corresponding icon flickers, then press the OK/Lock key for confirmation, the Fast Freeze function will get exited.

- When the Smart function or Holiday function is enabled, the Fast Cooling function will be disabled automatically.

## 5. Fast Freeze

When the Fast Freeze function is enabled, the freezer temperature will be controlled at -32°C automatically, and after 26 hours of running, the Fast Freeze function stops. Cooling down the freezer temperature in a rapid manner is beneficial to prevent loss of food nutrition and the preservation of foods freshness.



Under the Fast-Freezing mode, the freezer temperature is subjected to no adjustment.

- Enabling the Fast-Freezing function
  - Press the Function key to select Fast Freeze until the corresponding icon flickers, then press the OK key within 5 seconds for confirmation. If the OK key is not pressed within 5 seconds, the setting will be invalidated.
- Exiting the Fast-Freezing function
  - After a cumulative running period of 26 hours, the Fast Freeze function will stop automatically.
  - Under the Fast Freeze mode, press the Function key to select Fast Freeze until the corresponding icon flickers, and then press the OK key for confirmation, then the Fast Freeze function will stop.
  - When the Smart function is enabled, the Fast-Freezing function will be disabled automatically.

## 6. Smart

When the Smart function is enabled, the temperature of the fresh food compartment is controlled at 4°C, and the freezer compartment at -18°C, so that foods can be stored in the best condition while the refrigerator is running more efficiently and with better performance.



**Under the Smart Mode, the fresh food compartment temperature and the freezer compartment temperature are subject to no change.**

- Enabling the Smart function
  - Press the Function key to select Smart until the corresponding icon flickers, and then press the OK key within 5 seconds for confirmation. If the OK is not pressed within 5 seconds, the setting will be invalidated.
- Exiting the Smart function
  - Under the Smart mode, press the Function key to select Smart until the corresponding icon flickers, then press the OK key for confirmation. The Smart function will stop.
  - When the Fast Freeze function is enabled, the Smart function will be disabled automatically.

## **7. Child Lock (For the product of the PCM plate door only)**

- When the Child Lock function is enabled, the temperature and function are unable to be changed.
- In case of no key operation within 3 minutes, the Child Lock function will be enabled automatically.

- **Exiting the Child Lock function manual**

- Press and hold down the Unlock key for 3 seconds, then the Child Lock function can be disabled.

- **Door Open Alarm**

If any door is open for more than 3 minutes, alarms will continuously sound, which can be stopped when any key is pressed, NOTE: Alarms will be restored after 3 minutes if the door is kept open. The alarms will not be lifted until the door is closed.

- **Power Cut Memory**

In the case of power failure, the refrigerator will maintain the running state that is set before the power outage, when the power supply is restored.

- **Power-on Delay**

In order to protect the refrigerator compressor from being damaged in the case of short-time power failure (i.e., less than 5 minutes), the compressor will not be started immediately after it is powered on.

- **Over-temperature Alarm (only after power outage)**

When the refrigerator system is powered on, if the freezer sensor temperature is higher than -10°C, digits of the freezer zone flicker on the display. The freezer temperature can be displayed when any key is pressed, and the normal display will be restored when any key is pressed again or after 10 seconds.

- **Fault Alarm**

In case E0, E1, E2, EH, or EC is displayed on the operation panel, it indicates fault with the refrigerator. Please contact the after sales service center.

## V. Instructions for food storage

### Precautions for use

- The appliance might not operate consistently (if there is a possibility of defrosting or temperature becoming too warm in the frozen food compartment) when running for an extended period of time below the cold limit of the temperature range for which the refrigerating appliance is designed
- The information of climate type of the appliance is provided on the rating plate.
- The internal temperature could be affected by such factors as, the location of the appliance, ambient temperature, and frequency of door being opened, etc., and if appropriate, the setting of any temperature control device might have to be varied to allow for these factors should be made.
- Effervescent drinks should not be stored in the freezer compartment or the low-temperature compartment, and some products such as water ices should not be consumed too cold.

### Food storage location

Due to the cold air circulation in the refrigerator, the temperature of each area in the refrigerator is different, so different kinds of food should be placed in different areas. The fresh food compartment is suitable for the storage of foods that do not require to be frozen, as well as cooked food, beer, eggs, some condiments that need cold preservation, milk, fruit juice, etc. The crisper box is suitable for the preservation of vegetables, fruits, etc. The freezer compartment is suitable for the storage of ice cream, frozen food and the foods to be preserved for a long period of time.

### Use of the fresh food compartment

Set the temperature of the fresh food storage compartment between 2 °C & 8 °C, and store the foods that are intended for short-term storage, or to be eaten at any time in the fresh food compartment.

Fridge shelf: When removing the shelf, lift it up first, and then pull it out; and when installing the shelf, place it into position before putting it down. Keep the shelf rear flange upward, to prevent foods from contact of fridge wall. When taking out or putting in the shelf, hold it firmly, and handle with care to avoid damage.

Crisper box: Pull out the crisper box for access to food. After using or cleaning the cover plate of the crisper box, be sure to put it back onto the crisper, so that the internal temperature of the crisper box will not be affected.

### Use of the crisper humidity regulating rod (If applicable).

The humidity regulating rod of the crisper box is designed to maintain the humidity and freshness of the vegetables stored inside.

When the humidity regulating rod is slid to the right, with more holes exposed, lower humidity will be kept inside the crisper box.

When the humidity regulating rod is slid to the left, with less holes exposed, higher humidity will be kept inside the crisper box.

### Cautions for food storage

Before foods are put in the refrigerator, it is advisable to seal them, to prevent water

evaporation. Keep fresh fruits and vegetables on one section, this will help to prevent taint of odor in other sections of the refrigerator.

Do not over crowd the refrigerator. Keep enough space between foods because if foods are too close, the cold air flow will be blocked, thus affecting the refrigeration effect. Do not store excessive or overweight foods, to avoid the shelf from being crushed. When storing the foods, keep a distance away from the inner wall; and do not place the water-rich foods too close to the fridge rear wall, as there will be a risk of them becoming frozen to the inner wall.

### **Categorised storage of foods**

Foods should be stored by category, with the foods you eat every day placed in front of the shelf, so that the door open duration can be shortened and food spoilage due to expiration can be avoided.

Energy-saving tips: Allow hot food to cool down to the room temperature before putting it in the refrigerator. Put the frozen food in the fresh food compartment to thaw, using the low temperature of the frozen food to cool the fresh food, thus saving energy.

Use of the frozen food storage compartment

The freezer temperature is controlled below  $-18^{\circ}\text{C}$ , and it is advisable to store the food for long-term preservation in the freezer compartment, but the storage duration indicated on the food packaging should be adhered to.

The freezer drawers are used to store food that needs to be frozen. Fish and meat of large block size should be cut into small pieces and packed into fresh-keeping bags before they are evenly distributed inside the freezer drawers.

### **Fast freezing**

(1) Refer to the description about fast freezing function in the "Function" section.

(2) Compared with the normal freezing, fast freezing enables food to pass through the maximum ice crystal formation zone at the fastest speed. Fast freezing can freeze the food water content into fine ice crystals, without damaging the cell membrane, so cell juice will not be lost when thawing, and the original freshness and nutrition of food can be maintained.

(3) The fast-freezing function is designed to preserve nutrition of the frozen food, with the food is thoroughly frozen in the shortest time. Fast freezing consumes more energy than the normal freezing does.

### **Tips for Fridge/freezer storage**

- Allow the hot foods to cool down to the room temperature before putting them in the freezer compartment.
- Do not put a glass container with liquid or the canned liquid that is sealed in the freezer compartment, to avoid it bursting due to volume expansion after the liquid becomes frozen.
- Divide foods into smaller portions for freezing.
- Before freezing foods, ensure packing/bag used should be dry, this avoids the packaging/bags sticking together frozen.
- To avoid contamination and odour transfer, foods should be packed and/or covered by suitable materials. Eg firm, tasteless, impervious to air and water, non-toxic and pollution-free.



## Moving your Fridge/Freezer

- **Location**

Do not place your refrigerator/freezer near a heat source, e.g. cooker, boiler or radiator. Avoid it from direct sunlight in out-buildings or sun lounges.

- **Leveling**

Make sure to level your refrigerator/freezer using the front leveling feet. If not level, the refrigerator/freezer door gasket and sealing performance will be affected, or it may lead to the operating failure of your refrigerator/freezer.

After locating the refrigerator/freezer in position, wait for 4 hours before using it, to allow the refrigerant to settle.

- **Installation**

Do not cover or block the vents or grills of your appliance.

NOTE:

- If the appliance will not be used for several months, turn it off first, and then unplug the plug from the wall outlet.
- Take out all food.
- Clean and dry the interior thoroughly. To prevent odor and mold growth, leave the door ajar.
- Keep the cleaned appliance in a dry, ventilated place and away from the heat source, and do not place heavy objects on top of it.
- The unit should not be accessible to children's play.

## VI. Maintenance and cleaning



Before cleaning, turn off power first then unplug the appliance from the wall socket. Do not plug in or pull plug out with wet hands, because there is a risk of electric shock and injury.

Do not spill water directly on the refrigerator, to avoid rust, electricity leakage and accidents.

Do not stretch your hands into the bottom of the refrigerator, you might be scratched by sharp metal corners.

### Internal Cleaning and External Cleaning

The food residuals in the refrigerator are liable to produce bad odor, so the refrigerator must be cleaned regularly.

The fresh food compartment should be cleaned once a month.

Remove all shelves, crisper box, bottle racks, cover board, and drawers etc, and clean them with a soft towel or sponge dipped in warm water or neutral detergent.

Clear off the dusts accumulated on the rear panel and side plates of the refrigerator often.

After using detergent, be sure to rinse it with clean water, and then wipe it dry.



Do not use bristle brushes, steel wire brushes, detergent, soap powder, alkaline detergent, benzene, gasoline, acid, hot water and other corrosive or soluble items to clean the cabinet surface, door gasket, plastic decorative parts, etc, to avoid damage.

- Take care of the frozen foods in the event of an extended non-running of the refrigerating appliance (such as interruption of power supply or failure of the refrigerating system).
- Try to open the refrigerator door as less as possible, to ensure food safety and food is kept fresh for hours even in the hot summer.
- If you get the power outage notice in advance:
  - 1) Adjust the thermostat knob to the high mode an hour in advance, so that foods get fully frozen (Do not store new food during this time!). Restore the temperature mode to the original setting when power supply becomes normal in a timely manner.
  - 2) You can also make ice with a watertight container, and put it in the upper part of the freezer, so as to extend the time for fresh food to be stored.



Note: Once the refrigerator is powered on and in use, it is best to use the fridge/freezer continuously under normal circumstances to ensure not to affect the service life of the appliance.

### Defrosting

This appliance is designed with automatic defrosting function, thus no need to defrost it manually.

### Changing the lamp

The LED lamp is used by the refrigerator for lighting, which features low energy consumption and long service life. In case of any abnormality or if you need to replace the lamp, please contact the after sales service center on 01759 487823

### Safety-check after maintenance

Is the power cord broken or damaged? If yes, contact your after sales service centre

Is the power plug firmly inserted into the socket?

Is the power plug abnormally overheated? If yes, contact your after sales service centre



Note: Electric shock and fire accident may be caused in case the power cord and plug is damaged or stained by dust. If any abnormality, please switch power off to the appliance and then unplug the power plug and get in contact with the the service provider.

### How to Disassemble Bottle Racks and Fridge Shelves.

- Fridge door bottle rack:  
Hold the bottle rack with both hands, and then push it up.

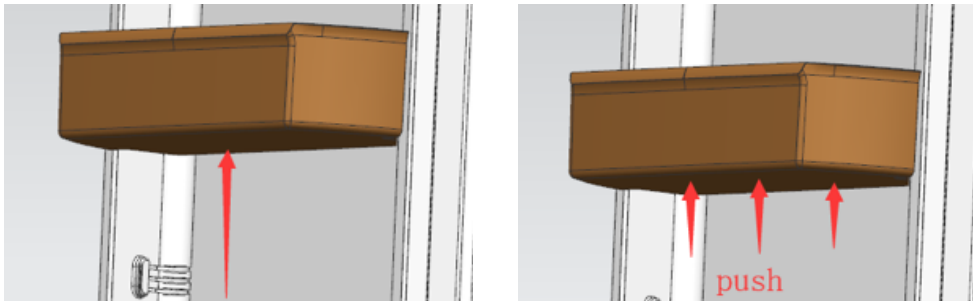

- Fridge shelf:  
Hold one end of the shelf, lift it up whilst pulling it outwards.

## VII. Trouble Shooting

With regard to the following small faults, not every failure needs to be fixed by the technical service personnel; you can try to solve the problem by referring to table below.

CASE	INSPECTION	SOLUTIONS
Completely non- refrigeration	<ul style="list-style-type: none"> <li>• Is power plug off?</li> <li>• Are breakers and fuses broken?</li> <li>• No electricity or line trip?</li> </ul>	<ul style="list-style-type: none"> <li>• Re-plug</li> <li>• Opening the door and checking whether the lamp is lit.</li> </ul>
Abnormal noise	<ul style="list-style-type: none"> <li>• Is refrigerator stable?</li> <li>• Does refrigerator make contact with the wall?</li> </ul>	<ul style="list-style-type: none"> <li>• Adjusting refrigerator's leveling feet.</li> <li>• Move appliances further away from the wall.</li> </ul>
Poor refrigerating efficiency	<ul style="list-style-type: none"> <li>• Do you put hot food or too much food in the fridge?</li> <li>• Do you open the door frequently?</li> <li>• Is the fridge in direct sunlight or near a furnace or stove?</li> <li>• Is it well-ventilated?</li> <li>• Temperature setting in too high?</li> </ul>	<ul style="list-style-type: none"> <li>• Putting food into refrigerator when hot food reached room temperature.</li> <li>• Checking and closing the door.</li> <li>• Relocate the refrigerator away from heat source.</li> <li>• Relocate fridge to location which has good ventilation.</li> <li>• Change setting to an appropriate temperature.</li> </ul>
Peculiar smell in refrigerator	<ul style="list-style-type: none"> <li>• Any spoiled food?</li> <li>• Do you need to clean refrigerator?</li> <li>• Have you packed food of strong flavors?</li> </ul>	<ul style="list-style-type: none"> <li>• Throw away spoiled food.</li> <li>• Clean refrigerator. (Recommended regularly)</li> <li>• Seal foods of strong flavors.</li> </ul>
No key response	<ul style="list-style-type: none"> <li>• Check whether the Child Lock function is enabled on the display panel.</li> </ul>	<ul style="list-style-type: none"> <li>• Press &amp; hold the "Unlock" key for 3 seconds to unlock the key, and then conduct the key operation. (For details, refer to the Child Key function.)</li> </ul>
Temperature setting impossible	<ul style="list-style-type: none"> <li>• Check whether the Smart or Fast Freeze function is enabled on the display panel.</li> </ul>	<ul style="list-style-type: none"> <li>• Exit the special function mode, and then set the temperature (for details refer to the Functions section)</li> </ul>
Freezer temperature displayed on the panel, with the temperature digits flashing	<ul style="list-style-type: none"> <li>• Is power cut before?</li> </ul>	<ul style="list-style-type: none"> <li>• Press any key to lift the alarm (refer to the Over-temperature alarm function), and then check the foods inside the fridge and freezer compartments are not spoiled.</li> </ul>



Note: If the trouble shooting advise does not resolve your problem, do not attempt to dissemble or repair this appliance. Repairs carried out by an inexperienced person may cause injury or serious malfunctioning. Contact your after sales service provider. This product should be serviced by an authorised engineer with only genuine spare parts.

When the appliance is not in use for long periods, disconnect from the electricity supply, empty all foods and clean the appliance, leaving the door ajar to prevent unpleasant smells and mould.

## VIII - Reversing the Door Swing

1. Make sure that your refrigerator is unplugged.
2. Pry the hinge cover up and off, remove the three screws that secure the upper hinge to the door, then remove the hinge.

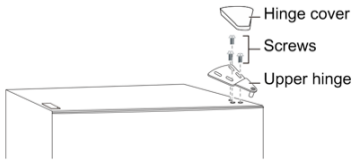

3. Remove the refrigerator compartment door from the cabinet.
4. Remove the two screws that secure the center hinge.

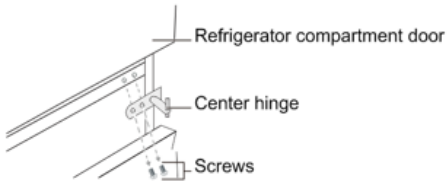

5. Remove the freezer compartment door.
6. Remove the screws that secure the lower hinge to the right side of the cabinet, then remove the hinge.

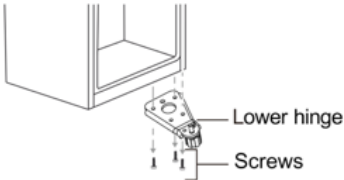

7. Remove the washer and nut that secure the pin shaft to the right hole on the lower hinge, then remove the shaft

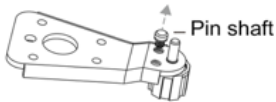

8. Insert the pin shaft into the left hole on the lower hinge, then secure the shaft with the washer and nut.
9. Install the lower hinge on the left side of the cabinet.
10. Remove the screw that secures the door stop from the bottom right of the freezer compartment door, then remove the door stop and install to the bottom left side.



11. Install the freezer compartment door.

12. Move the door bushing from the top right side of the freezer door to the top left side of the door. And move the left hole cover to the right side.

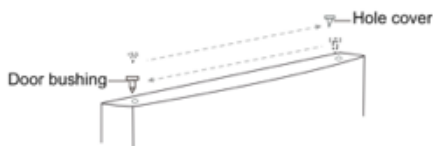

13. Remove the center hinge screw hole plug on the left side of the cabinet, then install in the screw holes on the right side of the cabinet.

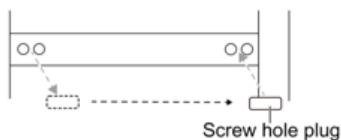

14. Install the center hinge to the left side with the two screws you removed previously.



15. Get the left door stop from the accessory bag, install it on the bottom left side of the refrigerator door.

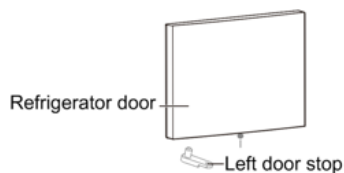

16. Install the Refrigerator compartment door.

17. Move the door bushing from the top right side of the Refrigerator door to the top left side of the door. And move the left hole cover to the right side.

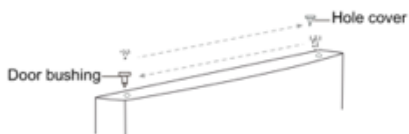

18. Remove the screw that secures the hinge screw hole cover from the top left side of the cabinet, remove the cover and secure the cover on the top right side of the cabinet.

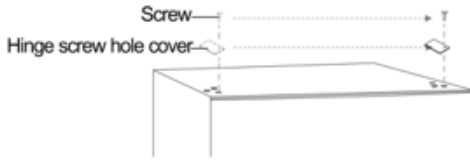

19. Secure the upper hinge to the top left side of the cabinet with the three screws you removed previously. Before you tighten the upper hinge screws, make sure that the top of the door is level with the cabinet and that the rubber gasket makes a good seal.  
20. Install the hinge cover over the hinge on the top left side of the cabinet.

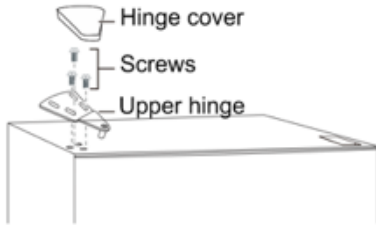



## **IX. Certifications**

### **Electrical information**

This electrical appliance must be grounded.

This product is equipped with a plug, which is suitable for all houses equipped with sockets meeting the current specifications.

If the fitted plug is not suitable for your socket outlets, it should be cut off and carefully disposed of by a qualified electrician. To avoid a possible shock hazard, do not insert the discarded plug into a socket.

This product complies the EEC directives.

## X. Product Support

### Declaration of conformance to product standards

This appliance conforms to all relevant standards applicable to domestic appliances sold in the UK

### Disposal



This appliance/fitting is marked A according to the European directive 2012/19/EU on Waste Electrical - and Electronic Equipment (WEEE). By ensuring this product is disposed of correctly, you will help prevent potential negative consequences for the environment and human health, which could otherwise be caused by inappropriate waste handling of this product.

The symbol on the product, or on the documents accompanying the product, the crossed out wheeled bin symbol, indicates that this appliance/fitting may not be treated as household waste. Instead it shall be handed over to the applicable collection point for the recycling of electrical and electronic equipment. Disposal must be carried out in accordance with local environmental regulations for waste disposal.

For more detailed information about treatment, recovery and recycling of this product, please contact your local authority, your household waste disposal service or the retailer where you purchased the product.

Old fridges and freezers contain isolation material and refrigerant with CFC. Therefore, take care not to harm the environment when you are discarding your old fridges.

## Guarantee

---



Your Teknix appliance comes with a 2 year parts and labour guarantee

Please REGISTER your appliance online at

[www.teknixwarranty.co.uk](http://www.teknixwarranty.co.uk)



You also have the option to **EXTEND YOUR WARRANTY** To 5 years parts and labour  
To register your appliance or extend your warranty  
Please call 01759 487823

---

We, Teknix, undertake that if within 24 months of the date of purchase this appliance or any part thereof is proven to be defective by reason of mechanical or electrical failure we will at our discretion repair or replace the same free of any charge for labour, materials or carriage on condition that:

- The appliance has been correctly installed in accordance to manufacturers' instructions.
- The appliance has been used for normal domestic purposes only and in accordance with our operating instructions.
- The appliance has not been repaired, taken apart or tampered with by any person not authorised by us.
- All repair work under this guarantee must be undertaken by the organisation or its authorised agents
- Proof of purchase is available on request
- If we decide your appliance cannot be repaired, or is uneconomical to repair, we'll replace it with the same model. If that model is no longer available, we'll discuss an alternative settlement with you.
- We reserve the right to charge for the expense of a service call if no fault has been found with the appliance after we have inspected it.
- All claims must be arranged via a call to us on 01759 487893. Without pre-authorisation it may result in the cost of claim not being reimbursed.

This guarantee is in addition to your statutory and other legal rights

### Exclusions

- Damage resulting from transportation, improper use, or neglect.
- Appliance outside the United Kingdom.
- Consumer replaceable items including, but not limited to, batteries, light bulbs and other consumables.
- Cosmetic damage and/or non-functional parts, which do not affect the normal use of the product including for example cabinet, scratches and rust.
- Any loss suffered as a result of not being able to use the appliance or any loss other than the repair or the replacement cost of the product.
- Accidental or physical damage